

Determine What the following circuits do (complete the graphs of input and output) and determine their input and output impedances.

1.

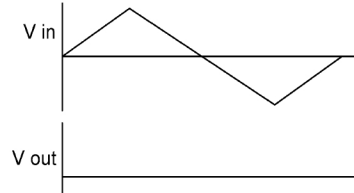

2.

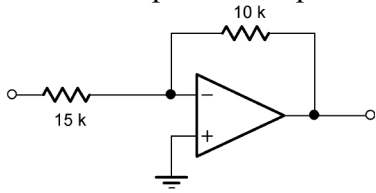
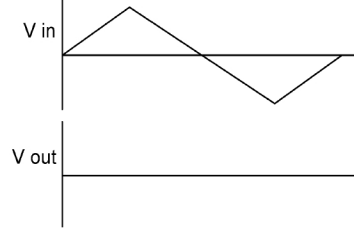
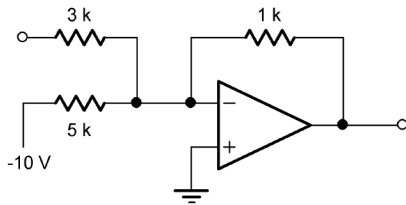

3.

BETTER DRAWING

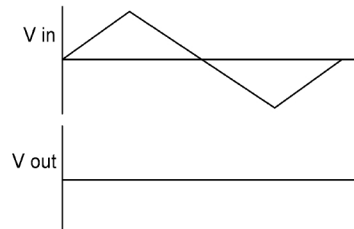
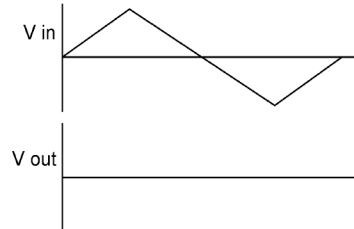
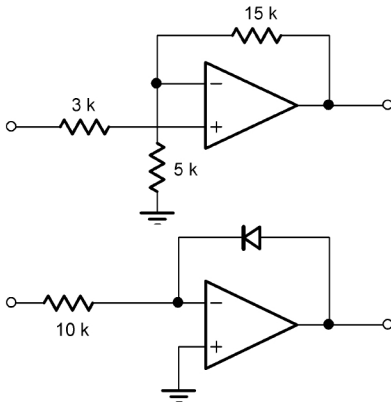
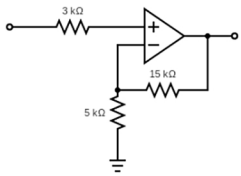

5. You have a photodiode light sensor. This acts like a normal diode in the dark, but when exposed light it creates a current in the backward direction through the diode more or less independent of the voltage across it. The current is proportional to the light intensity and in direct sunlight it is 6 mA. Create a circuit that has an output of zero volts when no light is shining on the sensor but outputs +5 V in sunlight. What will the output of your circuit be on a cloudy day when the diode only has a 1.5 mA current flowing? What is the output impedance of your circuit?